

Electrical connections

Connect the brown wire to terminal 7, the black wire to terminal 8 and the blue wire to number 9. The white wire and the grey handle control the auxiliary microswitch. (The connections refer to the diagrams shown below).

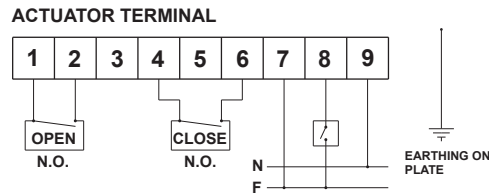

Shown below is an example of an actuator connection to a terminal. The brown wire must be connected directly to phase, the blue to neutral, and the black wire to the thermostat.

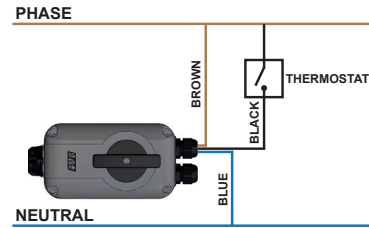

For parallel connection of several actuators, in addition to the brown, black and blue wires which are connected in this way to terminal, it is necessary to connect the grey and the white wires to the pump control in the boiler.

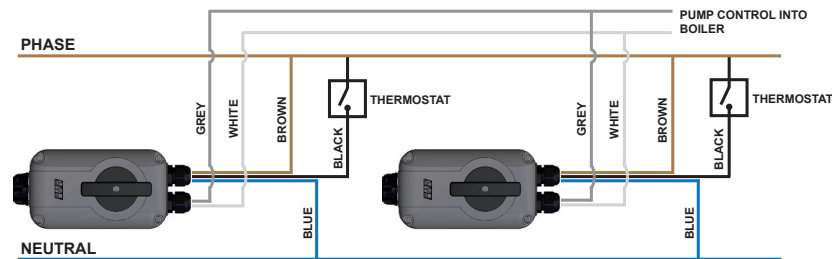

! According to installation rules, disconnection devices must be installed in order to avoid shorts circuits

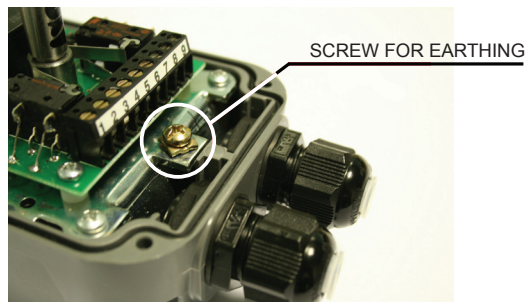

Technical assistance

Should technical assistance be required for zone valves or actuators do not tamper with the component, but contact: Technical Department - FAR Rubinetterie SpA Via Morena, 20 28024 GOZZANO (NO) ITALY tel. 0322.94722/956450 - fax 0322.93952 e-mail: ufficio.tecnico@far.eu



**1"1/2 AND 2" ZONE VALVES
 INSTALLATION INSTRUCTIONS**



2-way zone valves

Arts.303915	304015
303916	304016
303917	304017



3-way diverter zone valves

Arts.303920	304020
303921	304021
303922	304022

2-WAY VALVE

The two way full bore valve, Art. 3015, is a universal valve, suitable for all types of application. It is available with male-male, male-female and female-female connections.

The actuator opens or closes off the flow of fluid in response to signals received from the thermostat.

The zone valve features a special internal anti-blockage system, which prevents the valve blocking in even the worst operating conditions. The system comprises two PTFE seats located on two O-rings, which operate as "shock absorbers" so that ball rotation is guaranteed – even if it has not been used for a long period.

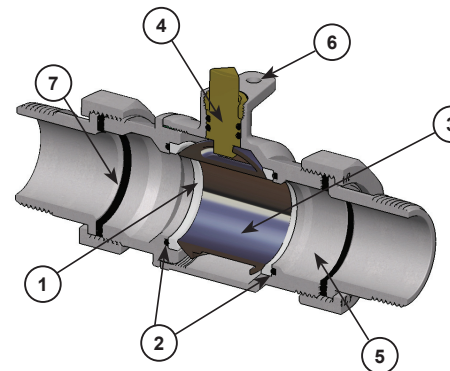

- 1- PTFE Seats
- 2- Sealing O-rings in EPDM
- 3- Ball in CW617N brass
- 4- Control stem in CW614N brass with O-rings in EPDM
- 5- Valve body in CB753S brass
- 6- Housing screw holes for actuator
- 7- Sealing in EPDM 80P

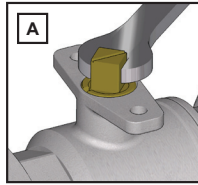

Stem positioning is carried out by means of a 11mm wrench, with which it is possible to rotate the flow indicator into the correct position (Fig. A). Before installing the actuator, it is essential to check that the flow aperture in the ball of the valve is orientated in the desired direction.

FULLY CLOSED VALVE

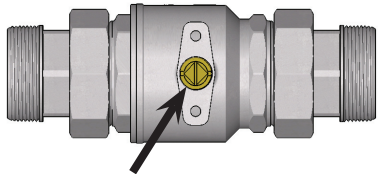

FULLY OPEN VALVE

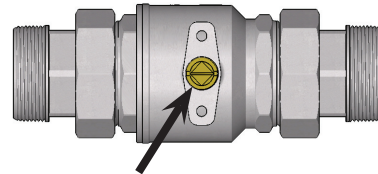

The actuator can be installed on the valve in either of two positions with no impact on operation, as the 90° movement transmitted to the valve remains the same.

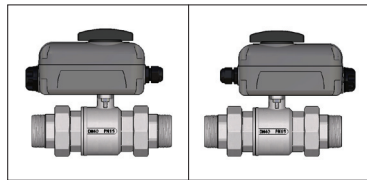

DO NOT INSTALL THE VALVE INVERTED

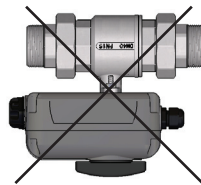

3-WAY DIVERTER VALVE

This is used to divert the flow from one circuit to another. It can be used in traditional heating systems, to divert the water back in case of thermostatic operation, or for switching in summer and winter to use the same circuit to heat or cool the room.

This valve can also be used in systems with both boiler and real fire fireplace.

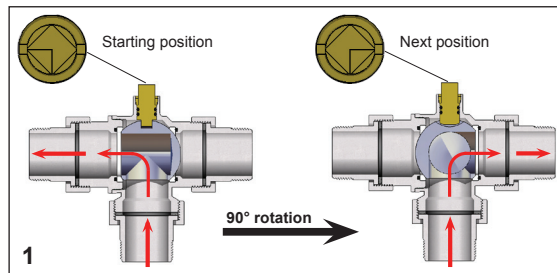

Pic.1 3-way diverter valve with fluid inlet from below and fluid delivery to the distribution pipework to either right or left according to the actuator position.

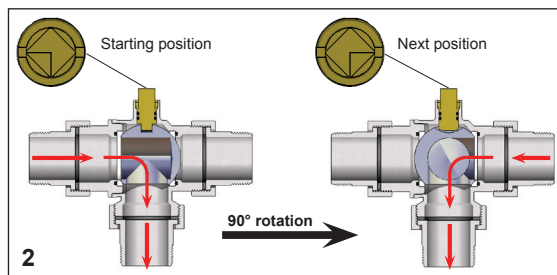

Pic.2 3-way diverter valve with fluid delivery towards the centre and inlet from right or left according to the actuator position.

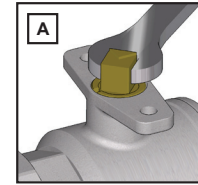

The stem of 3-way diverter valve is adjusted by means of a 11mm wrench, as shown in the Picture A

DO NOT INSTALL THE VALVE INVERTED

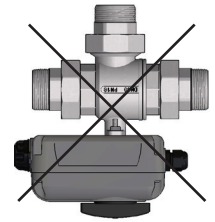

Illustration B shows how the position of the ball permits the inlet of fluid from below and then diverts it to the left. In the same position it can also permit fluid to enter from the left and then divert it downwards.

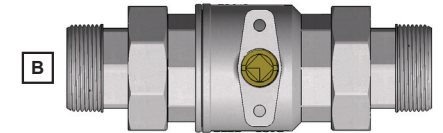
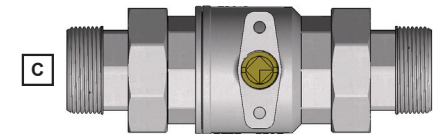

Illustration C shows how the position of the ball permits the inlet of fluid from below and then diverts it to the right. In the same position it can also permit fluid to enter from the right and then divert it downwards.



ELECTRIC ACTUATOR WITH MANUAL RELEASE, ARTS. 3039-3040

- Feed voltage: 230V 24V
- Torque: 35Nm (80s) and 20Nm (30s)
- Rotation time: 30s – 80s
- Rotation angle: 90°
- Absorbed power: 6,5 VA
- Max. room temperature: -10°C a + 50°C
- Protection level: IP65 (dust and water jets)
- Flanged ISO5211 (F3 e F5)
- Galvanized gearbox
- M4 screw for earthing
- Transmission by means of heat treated metal gears
- Mechanical stop (0°...90°) produced in the actuator
- Double safety O-ring on the end shaft
- Synchronous actuator with low consumption with bronzine and duty cycle of 100%
- Contact rating aux (opening and closing) 1A resistive

Installation

Insert the screw into zone valve holes

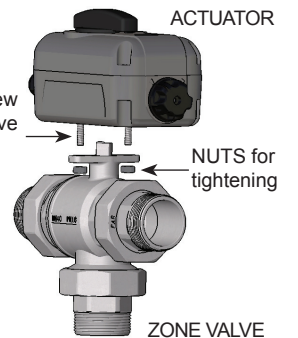

Manual release

The manual release system of the electric actuators Arts.3039-3040, is carried out by turning the handle clockwise until it reaches the position shown (position of manual release). Once this position has been reached, you can rotate - by means of the regulation handle - the valve on which the actuator is installed.

Usual operating position



Manual release position

